

FORD TRUCKS 3542P EURO6

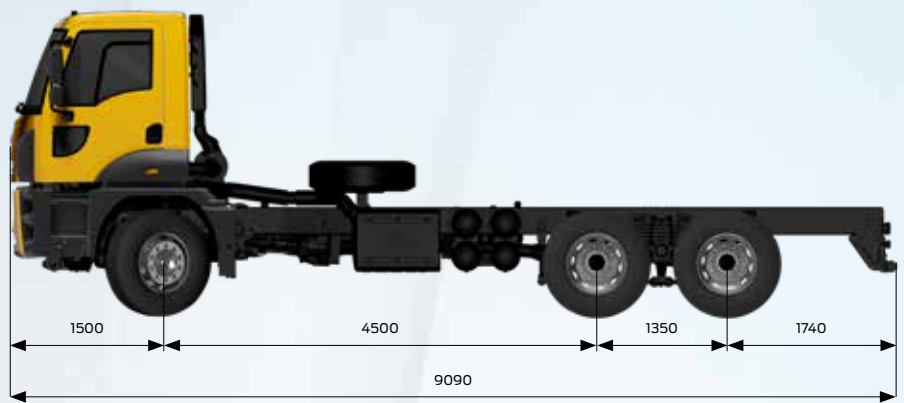

Basic Features

Vehicle Type	Concrete Pump
Axle	6x4
Emission	Euro 6
Cabin Type	Day Cab
Wheelbase (mm)	4500

Engine

Type	Ecotorq 12,7 liters
Displacement (cc)	12740
Bore x Stroke	130 mm x 160 mm
Power	420 PS (308,9 kW) / 1800 rpm
Torque	2150 Nm / 1000-1300 rpm
Compression Ratio	17 +/- 0,5 : 1
Oil Filling Volume	50 L
Coolant Volume	37 L

Transmission

Clutch	430 mm Single Disc
Manuel Transmission / Ratios (1. gear - 16. gear)	ZF 16S 2230 (13,805-0,836)

Steering

Power assisted single circuit

Chassis

Chassis Thickness	10 mm with Local Reinforcement
Chassis Strength	500 MPa
Suspension (Front / Rear)	90 mm Parabolic Leaf Springs / 100 mm Parabolic Tandem Suspension
Axle	Hub Reduction
Axle Ratio	4,08
Tyres	315/80 R 22,5
Wheel Rim	22,5 x 9 Steel

Braking System

Brakes (Ø mm x mm Length)	410 x 200 Z-Cam Brake System
Braking System	Dual Brake Circuit - Air Processing Unit with Integrated Oil Separator and Heater
Engine Brake Power	max. 340 kW (Engine Level)

Electrical System

Battery	24V, 2 x 12V 150 Ah
Alternator / Starter Motor	130 A / 6,5 kW

Tanks

Fuel Tank	315 L Steel
SCR Tank	55 L



Sharing the load

Dimensions (mm)	
Front Overhang	1500
Wheelbase	4500
Overall Length	9090
Distance Between 2 nd and 3 th Wheel Centers	1350
Overall Cab Length	1820
Overall Vehicle Height	3152
Overall Vehicle Width (Excluding Mirrors)	2540
Chassis Width	770
Rear Overhang	1740
Useful Chassis Length	6745
Chassis Height-Front	225
Chassis Height-Rear	285
Ground Clearance-Front	442
Ground Clearance-Rear	368
Turning Radius	9790

Weights (kg)	1. Axle	2. Axle	3. Axle	Total
Technically Permissible Weights	8000	13400	13400	34000
Kerb Weight	5525	2217	2217	9959
Payload	2475	11183	11183	24041
GVM (Legal)	8000	9500	9500	26000

STANDARD EQUIPMENT

- Manual Air Conditioner
- AM/FM/Aux In/USB/Bluetooth (Radio with Bluetooth)
- Conventional 4-point independent Cab Suspension for Day Cabin
- Cruise Control
- Drum Brake
- Engine Brake
- Anti-Lock Brake System (ABS)
- Pad Wear Indicator
- Differential Lock
- Electrically Operated Windows
- Electrically Operated and Heated Side mirrors
- Electrically Operated Headlight Leveling
- Rake and Reach Adjustable Steering Column
- Heated and Air Suspended Driver Seat and Fixed Passenger Seat
- Lumbar Support
- Front Vehicle Antiroll Bar
- Immobilizer
- Single Key with Remote Control and Central Locking
- Home Safe Lights
- Approach Lights
- Double Roof Marker Lamps
- Spare Wheel
- Short Bumper
- Switchable Air Compressor for Improved Fuel Economy
- Rear Window
- Horizontal Exhaust
- Tachograph
- Front Towing Hooks (Double Hook)
- Oil Pan Protection
- Ventilation Roof

OPTIONAL EQUIPMENT

- Cold Pack (Includes Wet Type Heater and 225 Ah Battery)
- Engine Driven PTO (includes Power Take off Control Unit)
- Manually Operated Sunroof
- Auxiliary Cabin Heater (Wet Type)
- Power Cab Tilting
- Metallic Paint / Special Colors
- Lateral Protection
- Dual Passenger Seat
- Automatic Traction Control (ATC)

This leaflet includes products designed for Ford vehicles. It provides information about the current technical specifications and the standard or optional accessories available as of the date it was issued. Features of standard and optional accessories of the vehicles may be changed from time to time. For this reason, please consult our Authorized Dealers to obtain updated and accurate information on the features of the vehicle you wish to buy. For the aforementioned reason, this leaflet does not constitute an assurance as to the specifications listed herein. The images used in this leaflet may be different from the vehicles on sale. The technical specifications provided herein are for standard vehicles. Selection of any optional accessories might cause differences from these specifications.